

**Genie Industries**



# ***Special Supplement to Genie Industries Operator's Manual***

---

***For Authorized and Trained  
Set Lighting Technicians  
and Studio Grips***

**▲ WARNING**

This manual is solely for use by set lighting technicians and studio grips who have completed training offered by qualified trainers in aerial work platform operation combined with use of set lighting, camera equipment and light diffusion frames. Users of this manual must be trained as Genie aerial work platform operators. Failure to receive training and to use the information contained in this supplement and in the operator's manual may result in death or serious injury.

First Edition, Third Printing  
Part No. 97636



# ***Special Supplement to Genie Industries Operator's Manual***

***For Authorized and Trained Set Lighting  
Technicians and Studio Grips***

## **Important**

This is a supplemental manual and modifications permitted herein are exceptions to normal operation. Instructions for normal operation are contained in the Operator's Manual for each machine.

Genie Industries reserves the right to modify this supplement without notice, or to revoke the modification approval if the supplement is used in a manner that creates a safety concern.

## **Contents**

	Page
Limited Purpose of this Manual .....	1
Proof of Training & Records Retention .....	1
Safety Rules .....	2
Wind Speed Chart .....	4
Platform Capacity Reduction Chart.....	5
Material Lifting Applications .....	7

## **Approved Models**

Z-60/34, S-40, S-60, S-80,  
Z-45/25, Z-45/25J, Z-34/22 IC

Copyright © 1999 by Genie Industries

First Edition: Third Printing, November 2004

"Genie" is a registered trademark of Genie Industries in the U.S.A. and many other countries.

These machines comply with ANSI/SIA 92.5-1992

 Printed on recycled paper

Printed in U.S.A.

## Limited Purpose of This Manual

This Supplemental Manual was prepared by Genie Industries at the express request of unions representing Set Lighting Technicians and Studio Grips. These operators requested Genie's written permission to use the Approved Models listed below in certain ways that deviate from Genie's standard manuals for that equipment. This Supplemental Manual contains Genie's written permission and the requirements that must be followed by specifically trained operators to enable them to use the Approved Models in the manner set forth in this Supplemental Manual.

## Proof of Training and Records Retention

Qualified trainers shall provide proof of training to all successful trainees. The document evidencing training shall include the following information:

- 1 The name of the person (operator) being trained or retrained.
- 2 The name of the organization providing training or retraining.
- 3 The name of the trainer(s).
- 4 Clear identification that the training covered the applications contained in this Supplemental Manual.
- 5 The date of training.

Records of training shall be retained by the trainers for at least four years and shall include all the information listed above.



---

## Warning

Failure to comply with the following requirements may result in death or serious injury.

---

- Any operator using Genie equipment in the manner set forth in this Supplemental Manual must be a Set Lighting Technician or Studio Grip AND must have completed a specific training course that complies with the requirements of this Supplemental Manual. If you are not a Set Lighting Technician or Studio Grip who has received specific training, do not deviate from the requirements of the standard Genie Operator's Manual for use of Genie equipment.
- Strict compliance with this Supplemental Manual, as well as Genie's standard Operator's Manual and Manual of Responsibilities, along with completion of specialized training, is essential to safe operation of the Approved Models as set forth in this supplement.

---

## Approved Models

Z-60/34, S-40, S-60, S-80,  
Z-45/25, Z-45/25J, Z-34/22 1C

# Safety Rules

## For the Attachment of Set Lighting, Camera Equipment and Light Diffusion Frames



### Danger

Failure to comply with the following requirements will result in death or serious injury.

**Modification of the Approved Models for use by attachment of lights, light mounting hardware, camera mounting hardware and light diffusion frames (LDFs) to the platform guard rail is authorized by Genie Industries only if the following rules and requirements are strictly followed:**

- Operators must have completed training for the attachment of lighting or camera equipment and LDFs to the platform guard rail. Training must include, but not be limited to, information regarding the effect on platform capacity and stability resulting from the attachment of equipment to the platform guard rail or to the boom of the aerial lift, and hazards associated with this application.
- All operating instructions and warnings contained in the Operator's Manual, Safety Manual and Manual of Responsibilities, and on decals found on the particular Genie aerial lift, must be followed.
- The aerial lift must be operated only on a firm, level surface.
- Operators must be trained and be able to demonstrate proficiency in the operation of the specific model of Genie aerial lift being operated.
- Genie booms are not insulated. Precautions shall be taken to protect the operator and people on the ground from electrocution hazards. The attachment of power supply cables to the boom shall not restrict the movement of the aerial lift or endanger the operator or people on the ground.
- Attachment of power supply cables to the boom shall be accomplished in a manner that does not cause a tip-over hazard due to a side or vertical force that could result in the machine becoming unstable.
- Power supply cables must be attached to the end of each boom section in a manner that ensures the cable cannot be damaged from tensioning, pinching or crushing when the boom is operated.
- LDFs hung from the platform guard rail must not be rigidly attached in any manner that could cause or impose a side or vertical load from wind or contact with adjacent objects greater than the rated side load posted at the entrance to the platform.
- Attachment of LDFs and rope to the platform shall be accomplished in a manner that does not cause a tip-over hazard due to a side or vertical force that could result in the machine becoming unstable.
- Do not alter the guard rail system by drilling, welding, crushing, damaging or making any other modifications that compromise the strength of the guard rail when attaching movie production equipment.

---

**SAFETY RULES**

- The entrance to the platform, the platform controls, including the foot switch and the emergency stop button, the lanyard anchorage points, the platform decals and instruction container must remain accessible when movie production equipment is attached to the platform.
- Operators must not gain access to or exit the platform by means of walking or climbing on the boom or lift structure or by attaching a rope or a hanging ladder from the platform or its supporting structure. Access to and exit from the platform shall be accomplished at ground level only.
- The combined weight of platform attachments, power supply cables, mounting hardware, platform occupant(s), tools and equipment must in all cases remain less than the maximum rated platform capacity. Use the platform capacity reduction chart found in this supplement to determine allowable platform load.
- The number and size of attachments must be limited by consideration of the maximum allowable wind speed and the surface area of platform attachments. Use the wind speed chart found in this supplement to determine maximum allowable wind speed.
- Information regarding the attachment of LDFs and lighting and camera equipment shall be supplied only to trained union members. Operators must be familiar with these supplemental instructions and warnings before they are allowed to operate any Genie boom that is approved for this application.

---

# Wind Speed Chart

For Light Diffusion Frames and Large Surface Area Platform Attachments on Genie Booms

Approved Models: Z-60/34, S-40, S-60, S-80, Z-45/25, Z-45/25J, Z-34/22 IC

## **⚠ DANGER** Tip Over Hazard

Using a boom in wind speeds greater than recommended or exceeding the recommended surface area of the platform by attaching movie production equipment may cause the boom to become unstable and will result in death or serious injury.

When movie production equipment, such as light diffusion frames or set lighting, is attached to a boom platform, operation in windy conditions is limited by the frame size (or total surface area of the equipment) and wind speed as follows:

<u>Frame Size (Area)</u>	<u>Maximum Wind Speed</u>
4' x 4' (16 sq. ft.)	25 mph
6' x 6' ( 36 sq. ft.)	25 mph
8' x 8' (64 sq. ft.)	25 mph
12' x 12' (144 sq. ft)	18 mph
20' x 20' (400 sq. ft)	11 mph

# Platform Capacity Reduction Chart

For Determining the Reduction In Platform Capacity Due To Attachment Of Movie Production Equipment To Genie Boom Platforms

Approved Models: Z-60/34, S-40, S-60, S-80, Z-45/25, Z-45/25J, Z-34/22 IC

## **DANGER** Tip Over Hazard

Exceeding the recommended load restrictions of the platform by attaching movie production equipment may cause the boom to become unstable and will result in death or serious injury. Always calculate the reduction of the platform capacity caused by attachment of more production equipment.

### **Theory:**

Platform maximum capacity is based on an evenly distributed load. When movie production equipment, such as light diffusion frames, set lighting and camera mounts, are attached to the front of the platform (entry side), the platform capacity is reduced by more than the weight of the equipment. The farther the equipment is mounted from the center of the platform, the greater the reduction in platform capacity.

### **Definition:**

**Center of Gravity (C.G.):** The balance point of an object. The point at which the entire weight of an object is concentrated so that if the object is suspended from that point, it will be balanced.

Reduce platform capacity according to the following:

- 1 Attachment of power supply cables to the boom reduces the platform capacity. Subtract the total suspended weight of cables and rigging from the rated platform capacity.
- 2 Subtract the load applied to the platform by the attachment of additional movie production equipment (as shown in the illustration below) by using the chart on the next page.

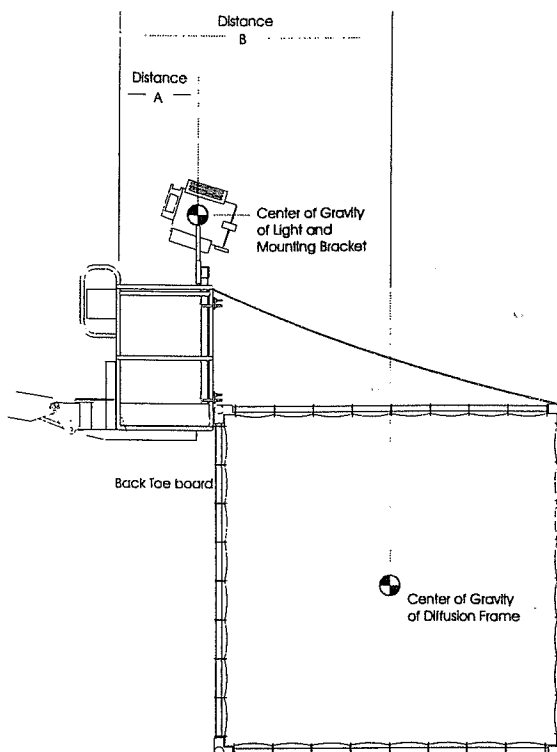

PLATFORM CAPACITY REDUCTION CHART

Weight of Equipment (lbs)	Load Center (inches) (Distance from back toeboard to center of gravity of load)												
	30	36	48	60	72	84	96	108	120	132	144	156	
50	67	69	81	94	106	119	131	144	156	169	181	194	
75	100	103	122	141	159	178	197	216	234	253	272	291	
100	133	138	163	188	213	238	263	288	313	338	363	388	
125	167	172	203	234	266	297	328	359	391	422	453	484	
150	200	206	244	281	319	356	394	431	469	506	544	581	
175	233	241	284	328	372	416	459	503	547	591	634	678	
200	267	275	325	375	425	475	525	575	625	675	725	775	
225	300	309	366	422	478	534	591	647	703	759	816	872	
250	333	344	406	469	531	594	656	719	781	844	906	969	
275	367	378	447	516	584	653	722	791	859	928	997		
300	400	413	488	563	638	713	788	863	938				
325	433	447	528	609	691	772	853	934					
350	467	481	569	658	744	831	919						
375	500	516	609	703	797	891	984						
400	533	550	650	750	850	950							
425	567	584	691	797	903								
450	600	619	731	844	956								
475	633	653	772	891									
500	667	688	813	938									
525	700	722	853	984									
550	733	756	894										
575	767	791	934										
600	800	825	975										
625	833	859											
650	867	894											
675	900	928											
700	933	963											
725	967	997											

 = Material Lifting Applications Only

**How to use this chart**

Note: The numbers in the shaded area on the chart are to be used for material lifting applications only. No personnel shall be in the platform if the rated platform capacity is exceeded.

Follow these steps for each piece of equipment attached to the platform.

- 1 Locate the weight of your equipment in the first column on the chart. Always round up to the next number.
- 2 Measure the distance from the back toeboard to the center of gravity of the equipment (distance A or distance B in the illustration on the previous page). This is the load center.
- 3 From these numbers, determine the total load of your equipment on the platform.

**Personnel lifting applications:** Subtract this number from the maximum platform capacity of the machine, as defined in the appropriate machine operator's manual and decals, to determine the remaining platform capacity.

**Material lifting applications:** Subtract this number from the maximum platform capacities called out on the range-of-motion charts on the following pages.

**Example:** Lighting equipment and the mounting bracket used to attach it to the guard rail weigh 167 pounds. Their center of gravity (balance point) is located at 35 inches from the back toeboard. Because the load is concentrated at the front guard rail, its effect on capacity is greater than a distributed load. The chart tells us that the reduction in capacity is 241 lbs. On a platform with a 500 lb capacity, the remaining capacity is 259 lbs (500-241=259).

---

# Material Lifting Applications Only

## Multiple Platform Load Rating Range of Motion Charts

**For Booms Used in Material Lifting  
Applications Only. No Operators Shall  
be in the Platform.**

### To determine boom extension:

When the boom is lowered, measure for allowable extension from the lower outside edge of the platform to the center line of the turntable bearing.

### **DANGER** Tip Over Hazard

Range-of-Motion charts apply to material lifting applications only. No personnel shall be in the platform when the boom is used in applications where the rated platform capacity is exceeded. Allowing personnel in the boom may cause it to become unstable and will result in death or serious injury.

- The Range-of-Motion charts on the following pages are for use by trained Set Lighting Technicians and Studio Grips only.
- Do not exceed the maximum load rating for each model shown on the following Range-of-Motion charts.
- The machine must be set on firm, level ground.
- Elevating a boom in windy conditions must be restricted to the instructions found in this supplement and in the operator's manual for the machine being used. Refer to the Wind Speed Chart on page 4.
- Platform loading must be restricted to the instructions found in this supplement and in the operator's manual for the machine being used.
- Do not use machines in tandem for lifting trusses.

MATERIAL LIFTING APPLICATIONS ONLY

**Maximum Load Rating Chart for Material Lifting Applications Only**  
No personnel shall be in the platform while the rated platform capacity is exceeded

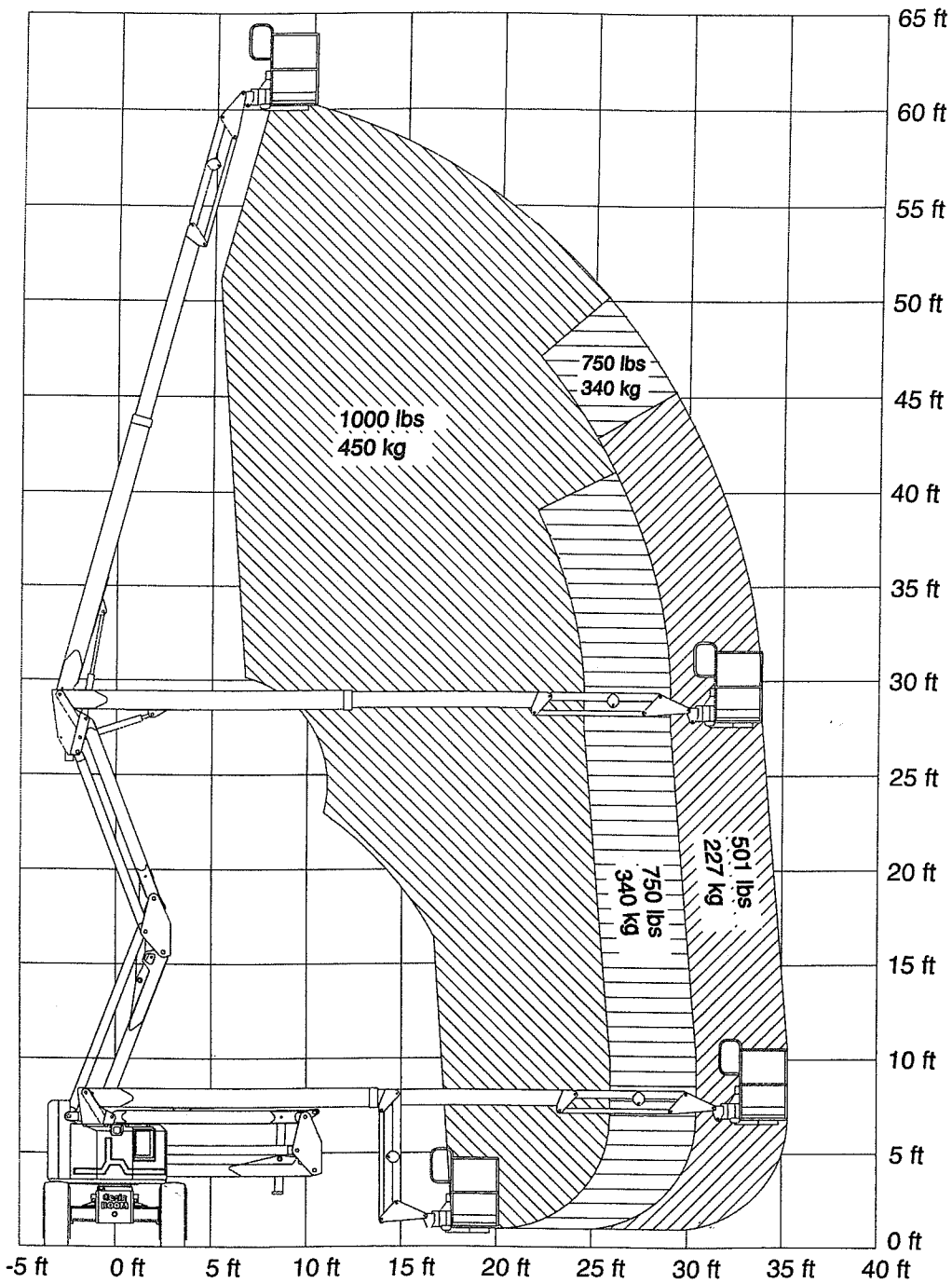

**Z-60/34**

MATERIAL LIFTING APPLICATIONS ONLY

**Maximum Load Rating Chart for Material Lifting Applications Only**  
**No personnel shall be in the platform while the rated platform capacity is exceeded**

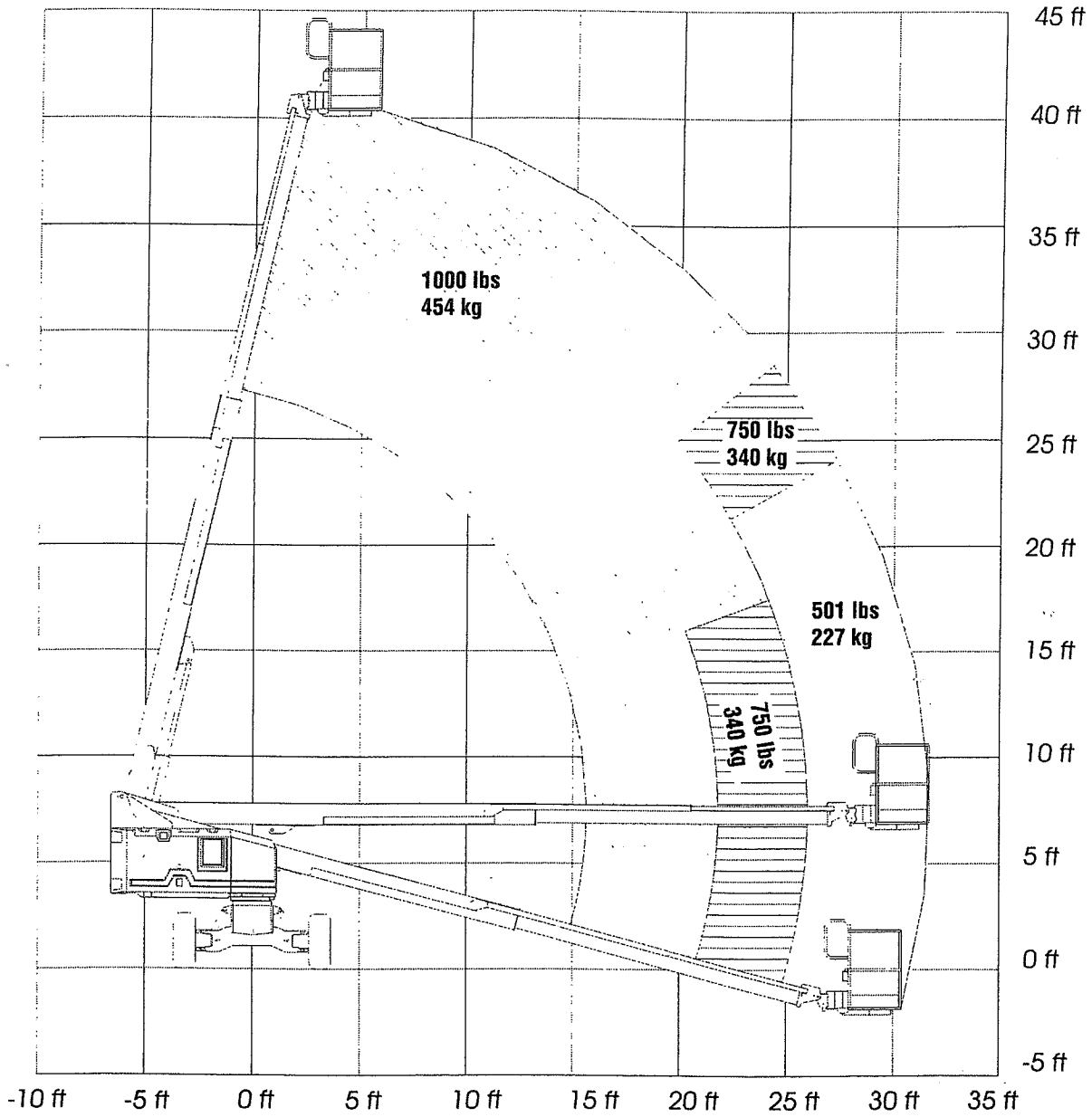

**S-40**

MATERIAL LIFTING APPLICATIONS ONLY

**Maximum Load Rating Chart for Material Lifting Applications Only**  
**No personnel shall be in the platform while the rated platform capacity is exceeded**

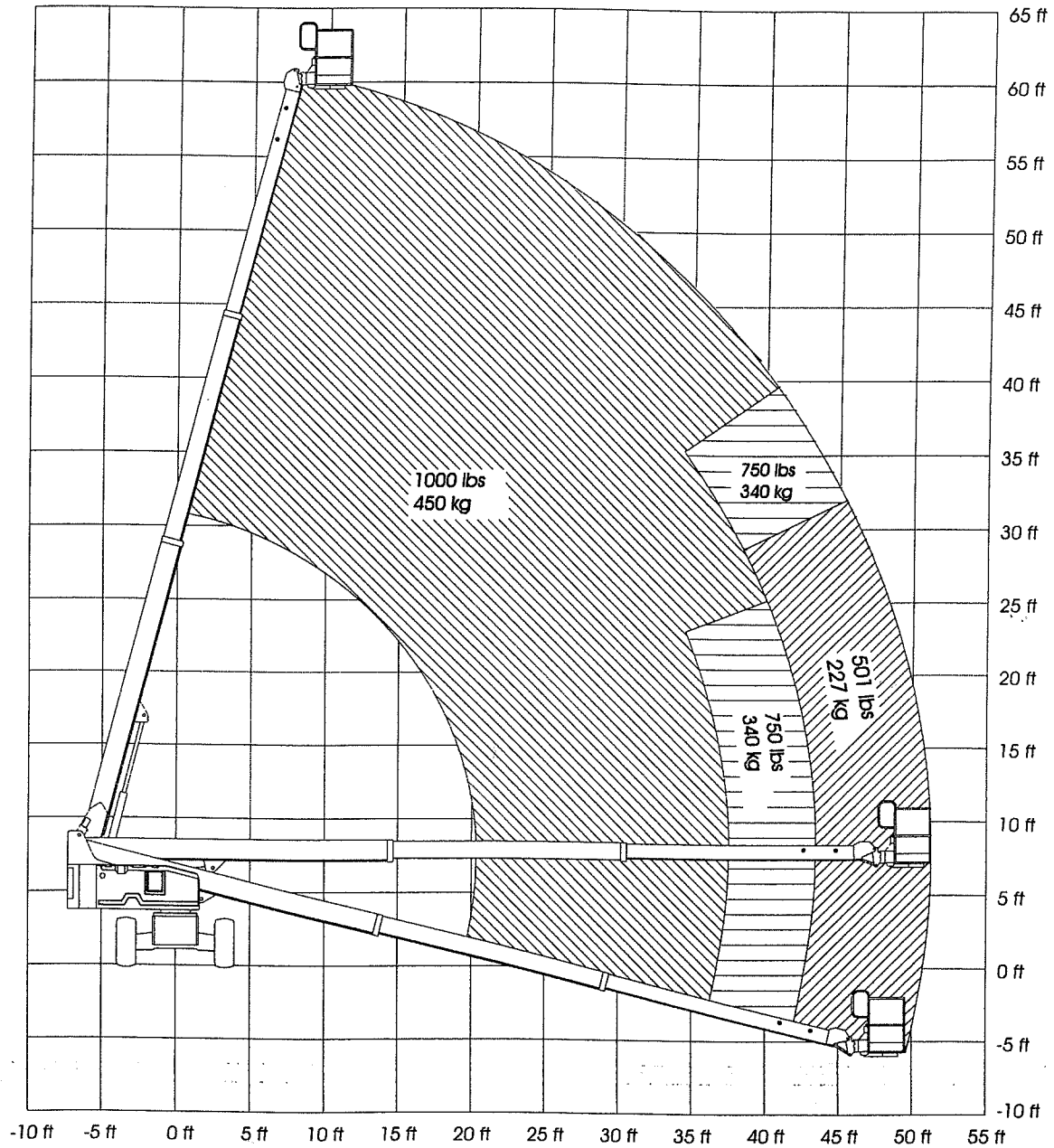

**S-60**

MATERIAL LIFTING APPLICATIONS ONLY

**Maximum Load Rating Chart for Material Lifting Applications Only**  
**No personnel shall be in the platform while the rated platform capacity is exceeded**

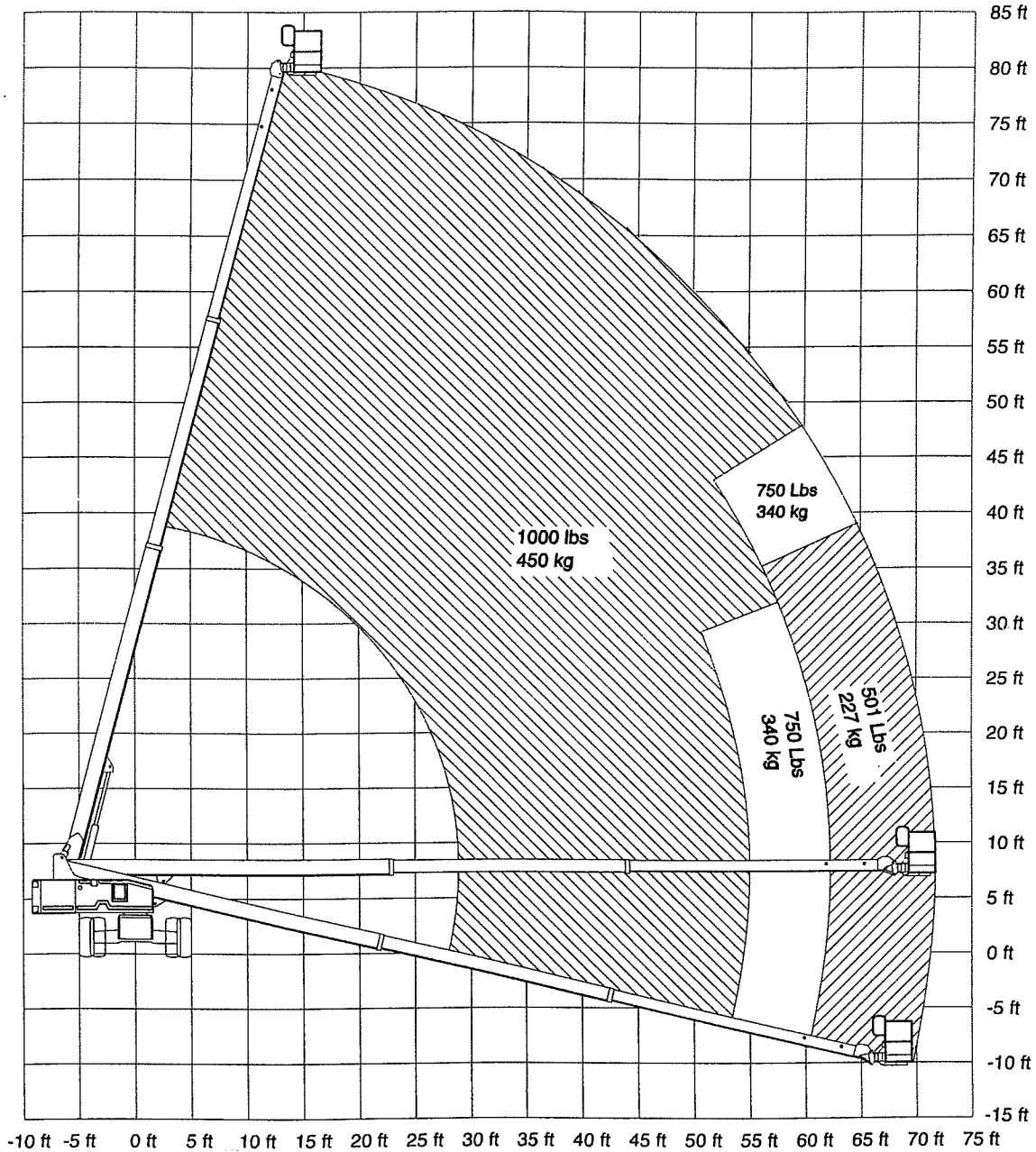

**S-80**

MATERIAL LIFTING APPLICATIONS ONLY

**Maximum Load Rating Chart for Material Lifting Applications Only**  
No personnel shall be in the platform while the rated platform capacity is exceeded

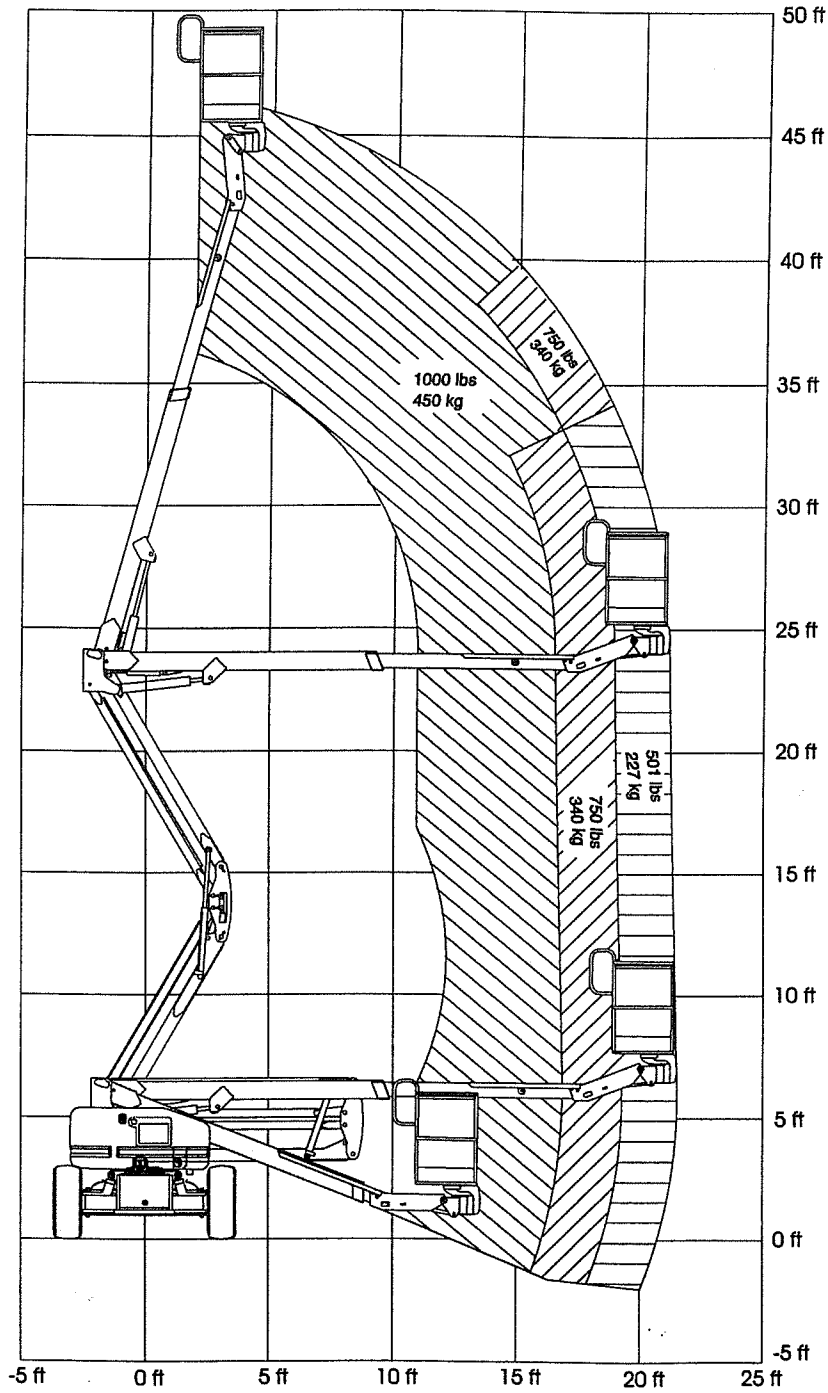

**Z-45/25**

MATERIAL LIFTING APPLICATIONS ONLY

**Maximum Load Rating Chart for Material Lifting Applications Only**

**No personnel shall be in the platform while the rated platform capacity is exceeded**

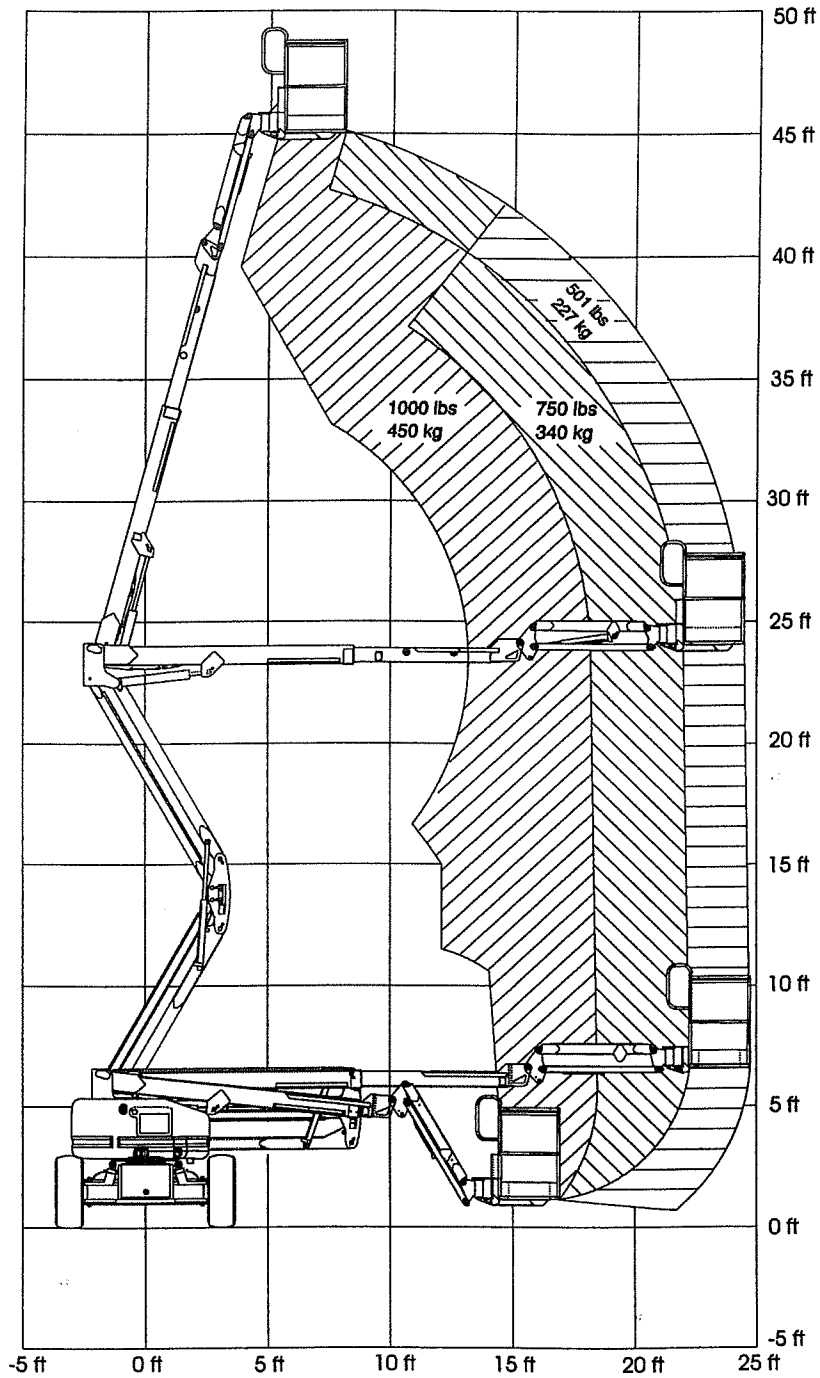

**Z-45/25J**

MATERIAL LIFTING APPLICATIONS ONLY

**Maximum Load Rating Chart for Material Lifting Applications Only**

No personnel shall be in the platform while the rated platform capacity is exceeded

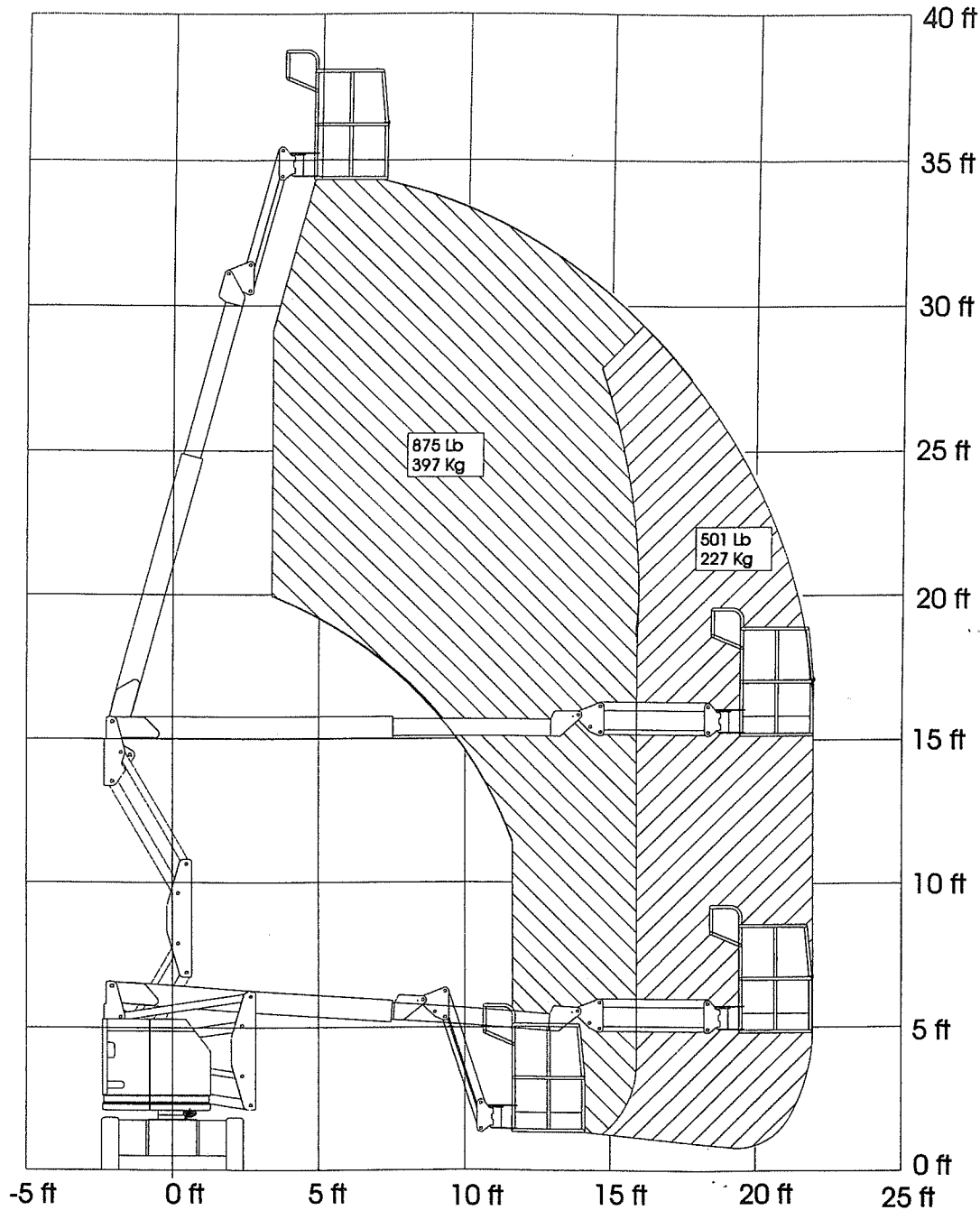

**Z-34/22 IC**

**California Proposition 65**

**!WARNING!**

The engine exhaust from this product contains chemicals known to the State of California to cause cancer, birth defects or other reproductive harm.

Distributed By: \_\_\_\_\_

[Empty rectangular box for distributor information]

**Genie North America**  
Phone: 425-881-1800  
Fax: 425-883-3475  
Toll Free in US &  
Canada: 800-536-1800

# Genie®

## Operator's Manual Supplement

First Edition  
First Printing  
Part No. 82943

## Cribbing Instructions

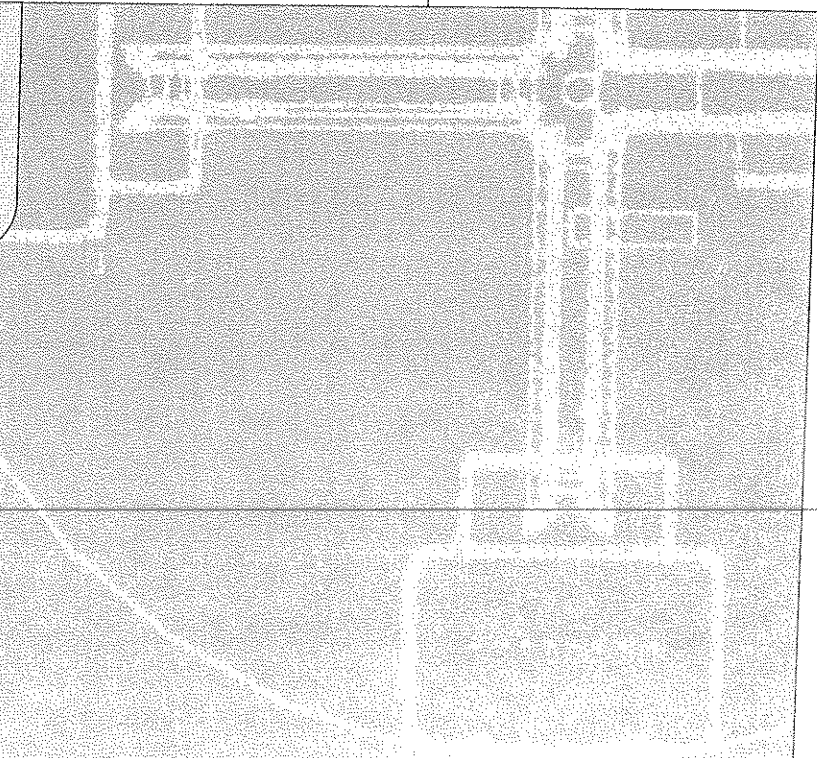

## Important

Plywood cribbing may be used to provide a level surface for safe boom operation. This instruction manual contains specifications for site constructed cribbing that, when used as instructed, may be considered firm and level ground. Cribbing may be used to bring a workplace surface to within the safe limits for aerial lift operation as described in the operator's manual.

Read, understand and obey the safety and operating instructions contained in the Operator's Manual for each machine.

## Contents

	Page
Safety Rules .....	1
Construction Specifications .....	2
Workplace Inspection .....	3
Instructions for Use .....	4

## Approved Models

S-40	Z-45/25
S-45	Z-45/25J
S-60	Z-60/34
S-65	Z-80/60
S-80	Z-34/22 IC
S-85	

Approved models must be equipped with pneumatic or foam-filled tires.

Copyright © 2003 by Genie Industries

First Edition: First Printing, December 2003

"Genie" is a registered trademark of Genie Industries in the U.S.A. and many other countries.

These machines comply with ANSI/SIA 92.5-1992

 Printed on recycled paper

Printed in U.S.A.

# Safety Rules

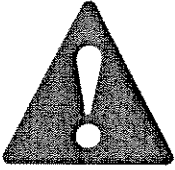

## Danger

Failure to read, understand and obey all warnings and instructions provided in this manual and the appropriate operator's manual will result in death or serious injury.

### **Use of plywood cribbing to provide a level surface for safe aerial lift operation is authorized by Genie Industries only if the following safety rules and requirements are followed:**

Do not use cribbing that is not built to the specifications outlined in this manual.

Operators must be trained in the safe use of aerial lifts on cribbing, using the information contained in this manual.

Do not use on booms over 85 feet (maximum platform height).

Do not use on any aerial equipment other than the models approved in this manual.

Do not use on a surface that is not firm (capable of supporting the weight of the machine without cribbing).

Do not use on a slope greater than 6° (10%).

Do not raise the platform unless the machine is level.

Do not drive the machine on cribbing with the platform raised.

Do not use cribbing over a hole, depression or bump in the supporting surface.

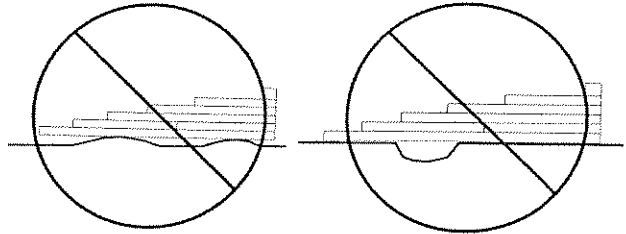

Machines must be equipped with a lock-out switch that disables the drive function when the platform is elevated. NOTE: If the machine does not have a lock-out switch, contact your Genie dealer to order a switch installation kit.

Do not raise the platform when wind speeds may exceed 15 mph.

# Construction Specifications

- Cribbing is to be constructed of APA certified plywood sheets.
- Each plywood sheet must be a minimum of  $\frac{3}{4}$  inch thick.
- Each plywood sheet must be a minimum of 24 inches by 24 inches.
- Plywood sheets must be layered together with a minimum of 24 inches of overlap for joints.
- Layers are to be secured with 6D ring shank nails, placed a minimum of 8 inches OC edge and 12 inches OC face. Use 8d ring shank nails for plywood over  $1\frac{1}{8}$  inches thick.
- Each end of the cribbing is to have a ramp or a chock that extends the full width of the cribbing. The chock must be a minimum of 6 inches by 6 inches.
- Ramps are to be constructed in a series of steps. Each step shall be a minimum of 12 inches long.
- The maximum total ramp height shall not exceed 8 inches.
- Make sure that machine wheels have a 24 inch surface to rest on when the platform is elevated.
- Cribbing must not be constructed to accommodate turns or curves.
- Cribbing must be constructed so that no machine tire is more than 8 inches off the ground at any time.

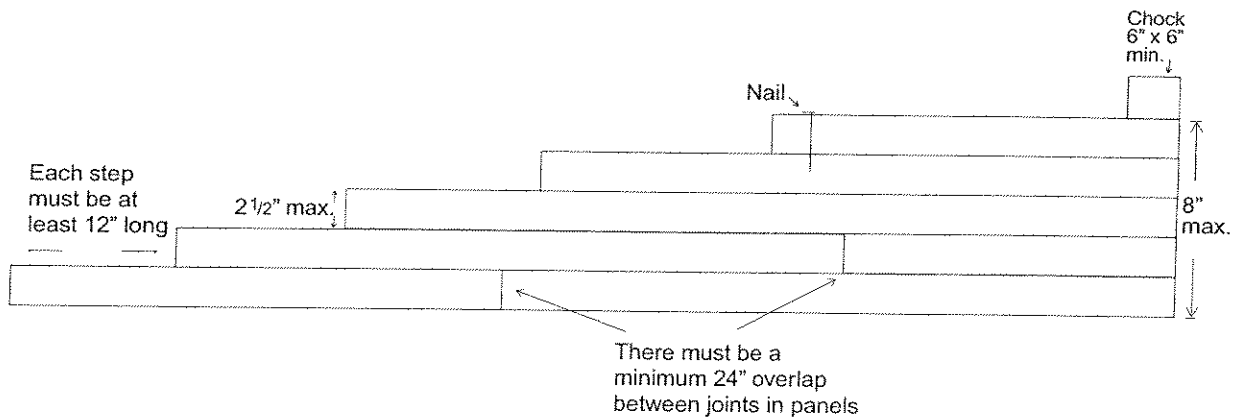

---

# Workplace Inspection

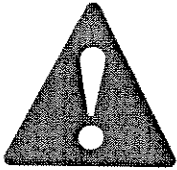

---

## Observe and Obey:

Read, understand and obey the instructions and hazards in the Workplace Inspection section of the operator's manual on your machine.

Conduct a workplace inspection prior to constructing and using cribbing to determine if the site is suitable for safe machine operation.

The workplace must be inspected before each use to determine if any changes have occurred that could affect the safe operation of the machine.

Be aware of and avoid the following hazardous situations when using cribbing:

- unstable surfaces that could shift under cribbing
- surfaces that cannot support the cribbing (refer to the floor loading specifications in the operator's manual)
- slippery surfaces that could cause cribbing to slide or skid
- sloped surfaces of greater than 6°
- drop-offs or holes
- raised ground

# Instructions For Use

- 1 Make sure you are properly trained in the use of aerial lifts on cribbing, using the information provided in this manual.
- 2 Make sure the Genie aerial lift has been modified with a lock-out switch that disables the drive function. This switch will be located on the ground control panel and labeled with a patch (part number 97549). NOTE: If the machine does not have a lock-out switch, contact your Genie dealer to order a switch installation kit.
- 3 Place the cribbing on a surface that complies with the requirements of this manual and the illustration below.
- 4 With the machine in the stowed position, drive onto the cribbing. The base of the machine must be level on the cribbing.
- 5 Move the drive disable switch to lock out the drive function.
- 6 Operate the machine lift function according to the instructions in the appropriate operator's manual.

